



COTI

by CRANE

Operator's Manual

Part Number PR15494001



Issue New - 03/2017

EC Declaration of Conformity

We Crane Merchandising Systems (UK),
of Pipsmore Park, Bumpers Farm Industrial Estate, Chippenham, Wiltshire, UK, SN14 6NQ

Declare that:

Type of Equipment: Beverage Vending Machine

Model Name: Coti

Has been designed and manufactured to comply with all essential requirements of the following Regulations/Directives:

2006/95/EEC The Low Voltage Directive and its amending directives

2004/108/EEC The Electromagnetic Compatibility Directive
and its amending directives

REG. (EC) 1935/2004 on materials and articles intended to come into contact with food relating
 REG. (EC) 10/2011 to plastic materials and articles intended to come into contact with food
 stuffs

The Essential Requirements of the European regulations for CE marking application are:

1. Mechanical resistance and stability
2. Safety in case of fire
3. Hygiene, health and the environment
4. Safety in use
5. Protection against noise
6. Energy economy and heat retention

Tests have been performed by accredited certification bodies in accordance to the following specifications:

Low Voltage Directive EN 60335-1:2002+A1:2004+A11:2004+A12:2006+A2:2006+A13:2008

EN 60335-2-75:2004+A1:2005+A11:2006+A2:2008+A12:2010

EMC Directive: EN 55014-1:2006+EN55014+A1:2009+A2:2011

EN 55014-2:1997+A120

EN 61000-3-2:2006+A1/A2:200 EN 61000-3-3:2008

EN 61000-4-2:2009 EN 61000-4-3:2012 EN 61000-4-4:2004

EN 61000-4-5:2006 EN 61000-4-11:2010

With regard to hygiene for foodstuffs in location, the operator must comply with 852/2004/EEC which lays out the general and specific hygiene rules to ensure a high level of consumer protection with regard to food safety.



Gillian White
 Vice President, General Manager Global Coffee

Date: 01/01/2017

Table of Contents

Introduction/Important Safeguards 2

Section 1 – Machine Specifications 4

Section 2 – Installation 5

Section 3 – How to Vend a Drink 12

Section 4 – Cleaning and Refilling Procedures 15

Section 5 – Service Keypad Functions 23

Section 6 – Programming Mode 25

Section 7 – Operator’s Programme 27

Section 8 – Dispense Pipe Lengths 36

Section 9 – Recommended Spare Parts 37

Section 10 – Error Messages and Simple Problem Solving 39

Section 11 – Decommissioning Your Machine 42

The following Symbol is used throughout this Operator’s Manual:



Safety First! Take care, risk of personal injury.

Crane Merchandising Systems accepts no responsibility for damage caused to the equipment through misinterpretation or misuse of the information contained in this manual.

© Copyright 2017 Crane Merchandising Systems

Introduction

This manual provides you with guidance on the installation, daily operation and basic programming of your Coti vending machine. Crane Merchandising Systems always recommend that a trained technician service its equipment.

Crane Merchandising Systems are committed to continuous product improvement. This means that the information within this document, although correct at time of publication may be subject to change without prior notice.

Important Safeguards

Always follow these basic safety precautions when operating or maintaining your machine:

1. Ensure that you and anyone who will operate or maintain your machine have this manual available for quick and easy reference and have read all instructions carefully before commencing work.
2. **Beware of Electricity.** Certain maintenance operations require your machine to remain connected and switched on. Only trained personnel should carry out these routines. Observation of safe working practices in accordance with current regulations is necessary at all times.



Important! Unless otherwise specified, always disconnect your machine from electricity supply before commencing work.

3. Do not operate your machine if any part is damaged until a service technician has carried out necessary repairs and ensured that it is safe.
4. Allow your machine to cool before handling or moving.

5. Never immerse your machine in water or any other liquid and never clean it with a water jet.
6. If your machine should freeze up, call a service technician to before switching it on.
7. Ensure that you are familiar with the most recent Health and Safety at Work Electricity at Work Regulations.



Important! This appliance is not intended for use by persons (including children under 8 years old and the infirm) with reduced physical, sensory or mental capabilities, or lack of experience and knowledge, unless they have been given supervision or instruction concerning use of the appliance by a person responsible for their safety, and they fully understand the hazards involved.

Children should be supervised to ensure that they do not play with the appliance.

Children must not carry out any cleaning or maintenance of the machine.

Your machine is for indoor use only and because it is a beverage vendor, should be sited in a clean and hygienic area.

Section 1 – Machine Specifications

Specifications

1.1 General

Height..... 1830 mm
 Width 700 mm
 Depth 785 mm

1.2 Electrical Services

Voltage..... 220 - 240 Volts AC
 Current..... 13 Amp Fused
 Frequency 50/60 Hz

Cup Capacity 800* 7oz

*Approximate and are for guidance only.



1.3 Water Services

Pressure 200 kPa (2 Bar) - 600 kPa (6 Bar)
 Stopcock..... 15 mm BSP from rising main

1.4 Sound Levels

A-weighted sound pressure level is below 70dB.

All weights and dimensions are approximate and are for guidance only.

Section 2 – Installation



Important! It is essential that any other personnel responsible for installing and servicing your machine understand the following:

1. The installation and commissioning of your machine should **only** be carried out by a **trained and authorised service engineer**.
2. All water and electrical services must be correctly and safely connected in compliance with national and local regulations.
3. All covers must be replaced securely and the machine left in a safe condition.

2.1 Siting your Machine

1. Your machine is suitable for indoor use only. We recommend that it be situated in an area with an ambient temperature not below 10⁰ C and not exceeding 30⁰ C. Your machine should be located near services as detailed in section 1.
2. It must also not be sited in an area where a water jet could be used.
3. Prior to placing your machine in its final location, ensure that there is sufficient access space available via passageways, stairs, lifts, etc.

4. Ensure that access to the machine is restricted to personnel who have knowledge and practical experience of the appliance, in particular as far as safety and hygiene are concerned.
5. To ensure adequate ventilation, 100 - 150 mm (4 - 6 inches) clearance must be allowed between the back of the cabinet and the wall.
6. Remove all transit packing, installation kit and box containing the cup turret tubes from the machine. Check for visual signs of damage which may have occurred during transit. If your machine is damaged or any parts are missing you must contact the supplier immediately.
7. Level your machine by adjusting the feet.
8. Ensure that the door opens and closes easily.

2.2 Connecting the Water Supply

1. Your machine should be situated within 1 metre of a drinking water supply from a rising main, terminating with a stop-tap with 15mm outlet pipe.

N.B. The water supply should comply with national and regional regulations. (e.g. in the U.K. the Statutory Instrument No.1147 - “Water, England and Wales” and The Water Supply (Water Quality) Regulations 1989.

Dynamic water pressure at the stop-tap must be within the limits 200 kPa - 600 kPa (2 - 6 Bar).

2. Connect the flexi-hose (supplied with your machine) to the water supply. Flush the system thoroughly before connecting to the machine.

N.B. Always use the new flexi-hose as supplied with the machine when connecting your machine to the water supply. Never re-use a flexi-hose.

3. Ensure that the seal is correctly fitted. Ensure that all water supply fittings are tight.
4. Turn on the water supply at the stop tap and check for leaks.

2.3 Connecting the Electrical Supply



Safety First! Your machine must be earthed. The electrical safety of this appliance can only be guaranteed if it is correctly and efficiently earthed, in compliance with National and European regulations on electrical safety. Always ensure that the earthing is efficient. If you have any doubts, contact a qualified technician to check the system. On no account should it be earthed only to the water supply pipe.

The manufacturer declines all liability for damage resulting from a system which has not been earthed. On no account should it be earthed only to the water supply pipe.

The appliance must be connected to mains protected by a certified safety switch (double pole) with a capacity appropriate for the application and in

compliance with National and European regulations on electrical safety.

The appliance must be connected to a 220 - 230V 50/60Hz 13amp fused switched socket outlet, installed to the latest edition of the IEE regulations, using a 3 pin BS approved 13 amp fused plug for UK and in compliance with National and European regulations on electrical safety in other countries



Important! If the mains lead becomes damaged in any way it must be replaced by a lead available from the manufacturer.



Important! If any internal fuses become damaged or fail in any way they must be replaced by a special fuse available from the manufacturer quoting the information written on the label adjacent to the relevant fuse-holder.

2.4 Commissioning Procedure

A trained installation engineer must carry out the following procedure before your machine is used for the first time. Ensure that the electrical and water services to the machine are connected correctly. Check for leaks in the water supply.

1. Open the door of your machine.
2. Ensure that the waste bucket is fitted correctly. Clip the level probe and overflow pipes to the rim of the bucket.

3. **Cup Turret.** Unbox the cup tubes and lid and fit in place then fill with the correct size cups for the cup catcher fitted to your machine. Allow the cups to drop into the tubes directly from the packaging. DO NOT touch the cups with your hands.



Important! Do not fill the tube directly above the cup dispense position. Allow the cup turret motor to rotate a full tube to the cup dispense position. Rotating the cup turret by hand will damage the mechanism.

Note! If you are using paper cups, first inspect each sleeve for damage to the cup rims. Damaged cups must not be used.

4. The cup turret mechanism will index the first available cups to the dispense position. Fill the remaining empty cup stack with cups and replace the lid.

5. Press the **Cup Test** button [7], on the Service Keypad and ensure that a cup is ejected cleanly from the cup drop unit.

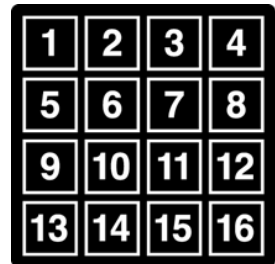

6. **All Models:** The water inlet valve will open and the heater tank will start to fill. Ensure that no water overflows from the heater tank overflow pipe into the waste bucket. Check the system for leaks.

Note! The machine has a safety feature which will allow the heater tank to fill for a maximum of two minutes. If after power-up the heater tank has not filled within this time, the mains power supply should be switched off and then on again to reset the heater tank time-out.



Important! Should the machine fail to fill correctly or leak, turn off the water and power to the machine before investigating the fault.

7. **All Models:** Rotate soluble/fresh brew ingredient canister outlets to upright position. The bean canister needs to have the outlet slide in the closed position before removal.

Place the canister into the canister filling station located on the door and fill canister with the correct ingredient.

DO NOT place the canister on the floor or overfill with ingredient.

Refit canister into machine ensuring that it is returned to the correct position. Remember to open the canister outlet slide once the canister is in position.

8. If fitted, check that the coin mechanism operates correctly. Fill the coin tubes. Ensure coin return mechanism functions correctly.



9. Operate the machine through its complete range of selections to ensure that each vend is correctly dispensed. Close the cabinet door. Ensure that the machine is left in a clean and safe condition.

2.5 Further instructions relating to the safe operation and maintenance of this machine are provided in the following sections.

2.6 Warranty Card

Please complete and return the warranty card that comes with the machine. Use the card to note any problems you encountered during installation, your feedback helps us to improve our products and services. Return the warranty card, whether problems were encountered or not.

Section 3 - How to Vend a Drink

The following example describes how to vend a **Tea** selection from a machine set to free vend.

If the machine has not been used for 3 minutes it will display the standby screen shown below.



3.1 Selecting a drink from the touch screen menu

Touch the screen to view the drink selection menu then press the selection required or **Next page** to view more selections.



3.2 Adding Milk/Sugar

If **Tea** is selected the touch screen will show the screen below. From this screen you can adjust the drink strength and add milk and/or sugar by touching the screen to highlight your choice.

e.g. regular, no milk or sugar

e.g. extra shot, regular milk and sugar



3.3 Vending a Drink

Once you have selected the drink of your choice press **Make my drink** on the screen.

As your drink is being prepared a progress spinner is displayed.

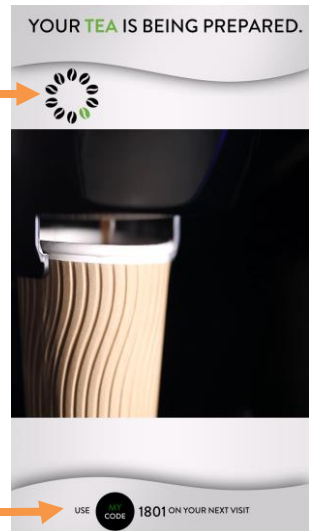

Whilst your drink is being prepared your My Code number is displayed. The number can be used on your next visit.

When your drink has been dispensed the machine will double beep and the screen opposite will be displayed.

When the drink is removed from the machine the Selection Menu is displayed, see Section 3.1. If the machine is then not used for a pre-determined time the Standby screen is displayed.

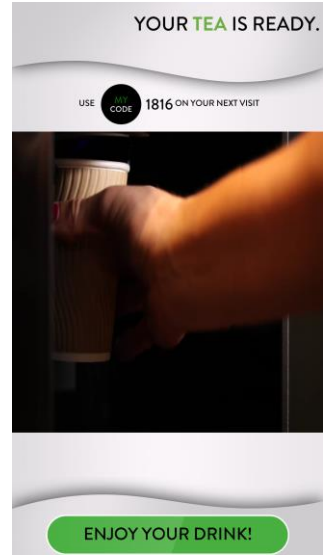

3.4 Selecting a drink using My Code

From the standby screen touch the **My Code** icon and the screen below is shown.

Add your code number and touch **Make my drink** to display the Selection menu, refer to above to Section 3.1.



Section 4 - Cleaning and Re-filling Procedures

The quality of drinks produced by your machine can only be maintained if it is cleaned regularly following the schedule outlined. You will need to have the following available:

- **Bactericidal Cleaner**
- **De-Staining Agent (as required)**
- **CoEx Cleaning Tablets (as required)**
- **Cleaning Cloths**
- **Paper Towels**
- **Small Brush**
- **Two Large Buckets**
- **Disposable Gloves (to be worn throughout these procedures)**

4.1 Bactericidal Cleaner

This can either be a liquid or powder agent which should be dissolved in water in accordance with the instructions on the product packaging. The solution should be used for cleaning machine components and wiping surfaces during the cleaning operation.

4.2 De-Staining Agent

This is a liquid or powder agent which should be dissolved in water and diluted in accordance with the manufacturer's instructions. The solution can be used on heavily soiled or stained components such as buckets and drip trays. Items or surfaces cleaned with this solution must be rinsed in clean water to remove traces of the cleaning agent.

4.3 Liquid Destainer - Brewer Units

Crane Merchandising Systems recommends that a liquid de-staining product is used for cleaning the brewer units fitted to fresh brew machines. The product must be used in accordance with the manufacturer's instructions, following all health and safety guidelines.

4.4 CoEx Cleaning Tablets – CoEx Brewer Units

Crane Merchandising Systems recommends that the correct cleaning tablets are used for cleaning the CoEx brewer. The product must be used in accordance with the manufacturer's instructions following all health and safety guidelines.

4.5 Daily Cleaning & Filling Procedure

Important: It is necessary to carry out the cleaning and maintenance procedure outlined on the following pages on a daily basis.

4.5.1 Ingredient Canisters - Removal and Cleaning

1. Rotate canister outlets to upright position. Remove the ingredient canisters. DO NOT place them on the floor.
2. With a clean, damp sanitised cloth wipe the exterior of the canisters. Ensure canister outlets are dried thoroughly after cleaning.



4.5.2 Mixing and Steam Extraction System

1. Remove the dispense pipe from the mixing bowl. Rotate the steam trap to clear the extract housing and remove from the mixing system.
2. Remove the mixing system by turning the green locking lever to the left and pull the mixing system away from the back plate.
3. Pull off the impeller and the rubber seal.
4. Clean all of the mixing system parts, including the steam traps, mixing bowls and dispense pipes thoroughly in the diluted bactericidal cleaner solution. Rinse all components with clean water and dry thoroughly.
5. Remove the extract tray from the machine. Using a dry brush, clean the area under the extract tray.
6. Clean the extract tray. Dry and refit to the machine. Wipe the canister shelf and the upper interior of the machine with a clean, damp sanitised cloth.

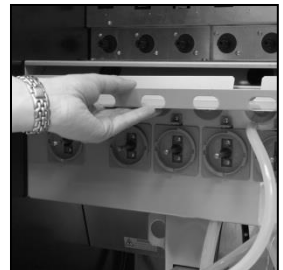

7. Refit the mixing system. Push the rubber seal onto the motor shaft and ensure it is pushed fully home into the recess in the base.
8. The impeller has a mark on the front face and a corresponding pip on the reverse. Line these marks up with the flat on the motor shaft and click the impeller onto the shaft.



9. Line up the mixing system to the base unit ensuring that the green lever is turned to the left. Press the mixing system home on to the base unit and press and turn the green locking mechanism to the right to lock in place.

Ensure the mixing system is locked securely in position.

10. Refit the steam traps to the mixing systems ensuring that the outlet lines up with the extract housing.



11. Press the securing tabs on each side of the dispense block and slide the block off the dispense head.

Clean thoroughly in the diluted bactericidal cleaner solution.

12. Rinse the dispense block with clean water and dry thoroughly before refitting to the machine.

13. Ensure the dispense pipes are refitted to their correct outlet position on the dispense block (see **Section 8 - Dispense Pipe Lengths** for details).

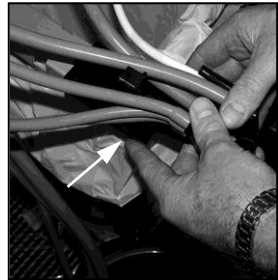

4.5.3a Oltre Brewer Cleaning Procedure

Daily Cleaning Procedure

Important: Cleaning and maintenance must be completed daily.

Fill a cleaning bucket with hot water and dilute the bactericidal cleaner in accordance with the manufacturer's instructions.

Open the door of the machine.

The brewer will always return to its fully open position at the end of the vend cycle. In the unlikely event that the brewer chamber is closed: -

Press '2' on the service keypad, the brewer will start to move and will stop at the open position. Disassemble the brewer as illustrated:

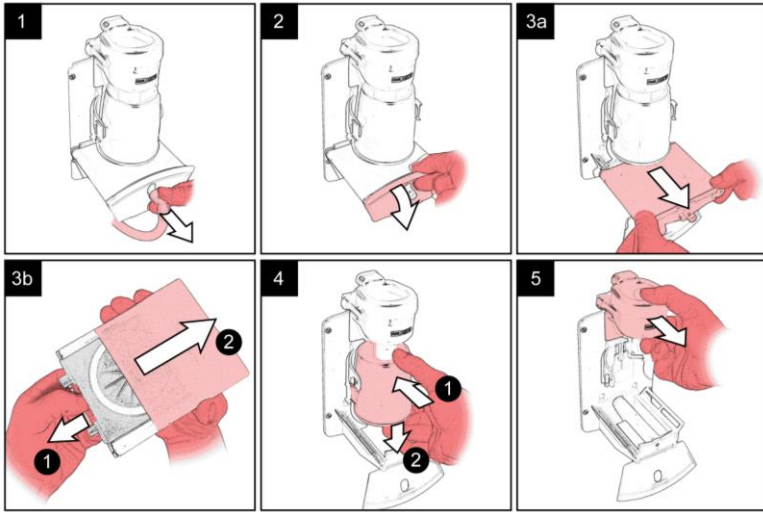

Clean the Oltre brewer chassis and mounting area.

Clean all of the Oltre brewer components.

Rinse all components with clean water, dry then refit to machine.

Weekly Cleaning Procedure

Important: Cleaning and maintenance outlined on the following pages must be carried out on a **weekly** basis.

Check that the Oltre brewer(s) are in an open position, if not then press '2' on the service keypad, the brewer will move and will stop at the open position

Remove the brewer chamber & filter belt assembly, then remove the belt. Clean all components with the recommended mix of de-staining solution; soak for 5 to 10 minutes.

Rinse all parts thoroughly in clean water & re-assemble into the machine.

Press the service keypad **Brewer Clean** button (4) and the machine will flush the brewer.

Empty the brewer waste container. Wash the waste container thoroughly.

N.B. If the feature has been turned on when the brewer waste container is emptied the waste counter must be reset. To reset the waste counter press button 12 on the service keypad, two audible bleeps confirm that the counter has been reset to zero.

4.5.3.b CoEx® B2C Brewer - Cleaning Procedure

4.5.3.b.1 Daily Cleaning Procedure

1. Remove the dispense pipe from the brewer outlet. Holding the unit as shown in the photograph, lift the green lever and carefully pull the brewer unit out of the machine.

Fill a cleaning bucket with hot water and dilute the bactericidal cleaning agent in accordance with the manufacturer's instructions.



2. Carefully place the CoEx® brewer unit into the diluted bactericidal solution and clean the unit thoroughly. Ensure all coffee ground deposits are removed, paying particular attention to the area around the top of the piston and waste chute.

Remove the unit from the solution and rinse thoroughly with clean water. Dry the unit using a clean cloth.



3. Remove the B2C coffee chute assembly. Unscrew the two knurled thumbscrews and remove the coffee chute and coffee chute cover.

With a clean, dry brush clean the area around and under the coffee dispense outlets.

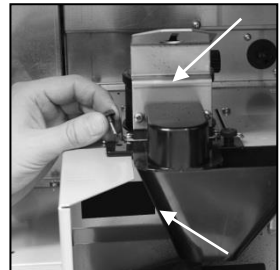

4. With a clean, dry brush wipe away any coffee deposits from both the coffee chute and cover mouldings.

Refit the coffee chute lid to the chute ensuring that the lugs on the cover fit securely into their mounting holes.

Refit the assembly to the machine and secure using the two knurled thumbscrews.

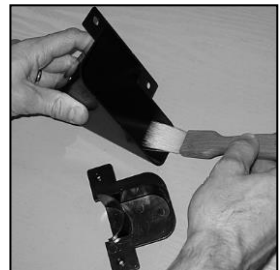

5. Refit the CoEx® brewer unit into the machine. Slide the unit into place until it 'clicks' into position. Refit the coffee dispense pipe to the brewer outlet as shown.

N.B. Depending how the machine has been setup the waste counter may need to be reset when the brewer waste container is emptied. This is done by pressing button [12] on the service keypad. Two audible bleeps confirm that the counter has been reset to zero.



4.5.3.b.2 Weekly Cleaning Procedure

The Coti has a routine cleaning cycle for the CoEx® brewer, with a warning message to indicate a clean is recommended or required. If the 'required' message is ignored B2C and fresh brew drinks cannot be selected until the brewer is cleaned, using the following procedure:



Caution: Ensure that a suitable container is placed under the dispense position. Keep hands away from the dispense area and brewer whilst the cleaning cycle is in operation.

1. Remove the brewer from the machine (see Section 4.5.3.b.1). Turn the locking ring anti-clockwise to the open position and remove the filter unit. Rinse the filter unit thoroughly, replace in the brewer and refit the brewer in the machine.
2. Press and release button [11] on the service keypad and follow the instructions on the main display. i.e. Press **Start Sanitation**. After rinsing and cycling the brewer the screen will display the message '**Please Place Cleaning Tablet in Brewer**'.



Take one cleaning tablet (supplied in packs of 30 - CMS part no. ZC10598000) and place it into the brewer chamber as shown.

3. Press the **Start Cleaning** touch-pad on the drink selection screen
4. The cleaning cycle lasts approximately 5 minutes and dispenses approximately 9 cups of water through the dispense head. The LCD will display the message '**Cleaning in Progress**' throughout the cleaning cycle.
5. When the cleaning cycle is complete the LCD will display the message '**Cleaning Completed**'. Press the **Finish** touch-pad on the drink selection screen to return the machine to standby mode.



Safety First! Never clean or service the brewer unit while it is in motion. Keep hands away from the dispense area and brewer whilst the cleaning cycle is in operation.

4.6 Waste Buckets & Syrup Containers

1. Remove the waste water bucket from the machine. Empty and clean.
2. If fitted; check the syrup levels in the syrup containers and replace if necessary
3. Clean the base, sides and back of the machine.

Refit the waste water bucket into the machine. Ensure that the level detector and overflow pipes are located correctly in the bucket.

4.7 Dispense Area Components

1. Remove the cup catcher moulding complete with drain pipe. Pull back the central catch to release the complete drip tray assembly. This can now be removed from its mounting brackets.
2. The drip tray assembly can be disassembled into its individual tray and grill components for ease of cleaning.



3. Clean the cup catcher and drain pipe in the sanitizer solution. Rinse the components with clean water and dry thoroughly. Wash the drip tray and grille thoroughly and sanitise using the diluted bactericidal cleaner solution.
4. Wipe clean the interior of the door, cup stand and the dispense area using a clean, damp sanitised cloth.



5. Refit the drip tray and cup catcher assemblies, ensuring that the drain tube from the cup catcher moulding is located correctly at the rear of the tray.
6. Remove and discard the drip catcher cup and replace with a new cup.

4.8 Touch Screen

Clean the glass on a regular basis to remove fingerprints or oily marks. Before cleaning the screen switch off the machine using the internal on/off switch above the product canisters.

Use a soft micro-fibre or lint-free cloth to gently wipe the screen. Dampen the cloth with water, glass or a screen lens cleaner to wipe the glass and dry. **Do not apply any liquids directly to the glass/screen.**

4.9 Cup Check

1. Check the levels of the cups in the cup turret and where necessary, refill with correct sized cups.



Important! Allow the cups to drop into the tubes directly from the packaging. **DO NOT** touch the cups with your hands. Do not fill the tube directly above the cup dispense position. Allow the cup turret motor to rotate a full tube to the cup dispense position when the machine is powered up. Rotating the cup turret by hand will damage the mechanism.

Note: If paper cups are being loaded, each pack of cups must first be inspected for damage to the cup rims. Damaged cups must not be used.

2. Replace the lid.

4.10 Cash Box

1. Open the coin mechanism cover. Wipe the inside with a cloth.
2. Remove coins from the cashbox and refit the cashbox to the machine.
3. Check the coin tubes and refill if required.

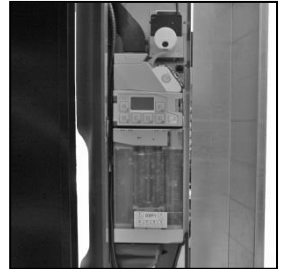

4.11 Test

Using the service keypad located in the rear of the door, proceed as follows:

1. Press the **Cup Test** button [7] and check that a cup is ejected correctly from the Cup drop unit.
2. Press the **Park Head** button [8] to ensure that the dispense head operates correctly and that the dispense pipes are fitted correctly.
3. Place a suitable container under the dispense head and press the **Rinse/Flush** button [3]. The machine will flush the system. Check that all of the mixing stations are water tight.
4. Press the **Test Vend** button [6] and using the selection buttons on the front of the machine, vend a drink to ensure that the machine operates correctly. Exit from the Test Vend menu.
5. If required press the **View Counters** button [5] and record the audit information.

Section 5 - Service Keypad Functions

Your machine is fitted with a service keypad mounted on the rear of the door. This keypad allows the operator to carry out specific functions for routine cleaning and maintenance.

N.B. During certain operations e.g. View Counters it is necessary for the operator to utilise the screen on the front of the door to access data.

The service keypad allows the operator to carry out the following functions:

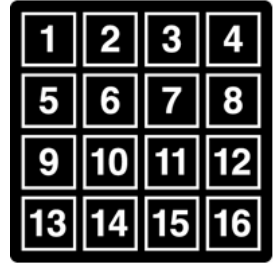

5.1 Button 1 – Not used

5.2 Button 2 - Brewer Open (Freshbrew Models Only)

Opens the brewer fitted to freshbrew machines and enables the operator to replace the filter paper used in paper type brewers or remove the brewer hopper/wiper assembly of paperless brewers.



Caution: Ensure power is isolated at the main switch before working on any open brewer.

5.3 Button 3 - Rinse/Flush

The flush sequence operates automatically and rinses the mixing bowls and brewers. Before the sequence begins, the system waits until the water in the heater tank is at the correct temperature. In order to guarantee the highest standards of cleanliness, the boiler fill valve is disabled, ensuring that the water used in the sequence is delivered at the optimum temperature to kill any micro-organisms. Each hot water valve and the corresponding whipper are switched on in sequence for a pre-set flush time.



Caution: Ensure that a suitable container is placed under the dispense position. Keep hands away from the dispense area whilst the flushing cycle is in operation.

5.4 Button 4 - Brewer Clean (Fresh brew Models Only)

Enables the brewer to be cleaned. In order to guarantee the highest standards of cleanliness, the boiler fill valve is disabled, ensuring that the water used is delivered at the optimum temperature to kill any micro-organisms. The brewer unit is filled with hot water and then operated through four cycles. Once the cleaning cycle is complete, the heater tank refills.



Caution: Ensure that a suitable container is placed under the dispense position. Keep hands away from the dispense area whilst the flushing cycle is in operation.

5.5 Button 5 - View Counters

This button enables the operator to access the Data Recall Menu where the operator is able to view Non-Resettable and Resettable Sales Data, data relating to Timed Events, Identification Numbers of installed components and SureVend™ information.

5.6 Button 6 - Test Vend

This button enables the operator to vend a drink from the machine to ensure correct operation after cleaning or maintenance.

1. When the button is pressed a drink can be selected from the menu displayed.
2. Exit from the Test menu by pressing the **Up one level** key-pad.

5.7 Button 7 - Cup Test

This button enables the operator to test the operation of the cup drop unit. When the button is pressed the cup drop motor is operated and a cup is dispensed.

5.8 Button 8 - Park Head

When this button is pressed, the dispense head moves to its fully extended position and stops.

Press the button again to return it to its homed position.

5.9 Button 9 - Boiler Fill (Espresso Machines Only)

When pressed, the machine pumps a measured amount of water through the system (approximately 400ml). This button should be used to purge any water left in the system after the machine has been moved or shut down for any length of time.

5.10 Button 10 - Machine Cool Down (Espresso Machines Only)



Important! This button enables an engineer to work safely on the water system and should not be used by the operator.

5.11 Button 11 - CoEx® Tablet Clean (Espresso Machines Only)

When pressed, initiates the CoEx® brewer tablet cleaning routine. Crane

Merchandising Systems recommends that this brewer cleaning routine should be carried weekly.

5.12 Button 12 - Reset Waste Counter (Fresh Brew & Espresso Machines)

When the waste container is emptied the counter must be reset.

When pressed the counter is reset, it is confirmed by pressing the OK button on the front screen

Note: Only relevant if the feature is enabled in the program (it is disabled by default)

5.13 Button 13 - Syrup Prime (Still/Carbonated Machines Only)

This button enables the operator to prime the syrup selections.

5.14 Button 14 - Not used

5.15 Button 15 - Start

When weighing ingredients within service mode this button has the same functions as **START** on the drink selection key-pads.

5.16 Button 16 - Not used

Section 6 - Programming Mode

6.1 Programming Interface

Programming mode allows the operator to view and change options within the machine.

6.2 Navigating through the Menu Display

1. Once you have gained access to the programming mode (**see sub-section 6.4 Accessing the Programming Mode**), the LCD displays the Operator's Main Menu.
2. A menu item is selected by pressing the corresponding touch-pad.
N.B. The bottom of the screen will often show important information. In many configuration menus it will display the current value for the selected item.
3. When a menu, sub-menu or data-display is split across multiple screens, the **Next Page** and **Previous Page** icons will be displayed.
4. To return to a previous menu screen, e.g. from the Diagnostics sub-menu up to the Main Menu, use the **Up one level** option.

6.3 Entering or Updating Parameters

To enter or update parameters, key in the actual digits of the number required using the touch-pads **0-9**. Once the correct parameter has been entered, press Save to overwrite the previous value and store the new parameter in the machines memory.

To return to the previous screen press the **Up one level** touch-pad.

Certain programming functions require that the operator choose either one or multiple parameters. These can take the form of either check boxes or radio buttons.

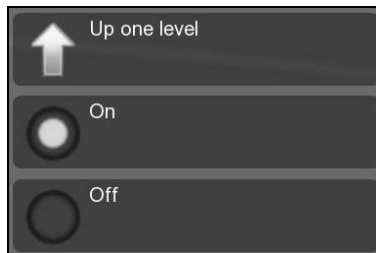

1. Select the required option, a filled radio button indicates that it is selected.
2. Using the touch-pads, select the day on which the Sanitation Event is to take place, a **TICK** appears in its adjacent box indicating that it is selected.

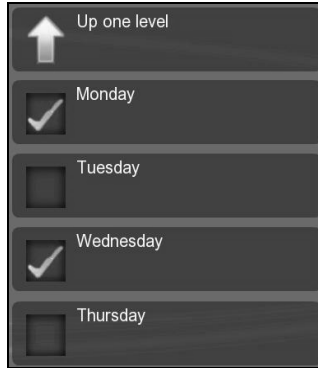

Continue until all required days have been selected.

6.4 Accessing the Programming Mode

1. Open the door of the machine. The LCD will automatically display the PIN entry screen; Enter the 4 digit operator's entry pin code and press OK.

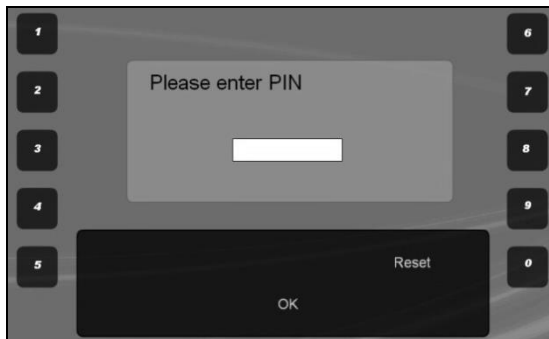

N.B. The factory default operator's code is **3-3-3-3**.

You may be issued with alternative code.

Section 7 – Operator's Program

Once in the Operator's Program, the LCD on the front of the machine will display the Main Menu (illustrated below).



7.1 Data Recall

Entry into this menu allows the operator to view Non-Resettable and Resettable Sales Data, data relating to Events and SureVend™ assisted vend information. The Re-settable Sales Data and SureVend™ data menus contain an extra sub-menu which allows the operator to delete the current data.

7.1.1 Non Resettable Sales Data

This menu allows the operator to view monetary and sales values. This data cannot be reset and will remain intact for the service life of the controller board.

1. Select **Non Resettable Sales Data** (Overall Totals, By Product, Cash, Cashless or Token Vends).

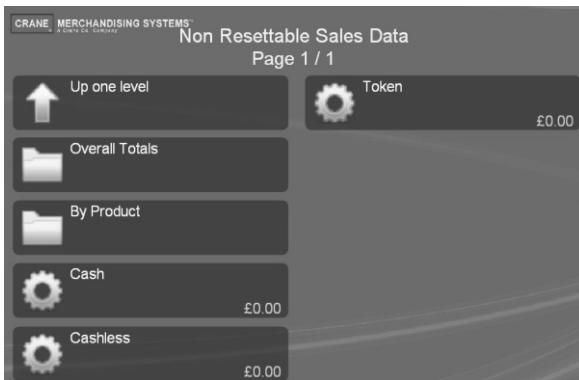

2. Select **Overall Totals**. This menu displays both the total monetary amount and total vend counts for the following data:

Data fields on the Overall Totals screen:

Sales-£	Displays the total machine sales in £ (NOT including Test Vends or Free Vends).
Sales-#	Displays the total number of machine vends. This value includes normal, discount and surcharge vend totals. (NOT including Test Vends or Free Vends).
Discount-£	Displays the total monetary value of all discounts in £.
Discount-#	Displays the total number of discounted vends.
Test Vend-£	Displays the total monetary value of all test vends in £.
Test Vend-#	Displays the total number of test vends.
Surcharge-£	Displays the total monetary value of all surcharges in £.
Surcharge-#	Displays the total number of surcharge vends.
Free Vend-£	Displays the total monetary value of all free vends in £.
Free Vend-#	Displays the total number of free vends.
Total-£	Displays the total machine sales in £.
Total-#	Displays the total number of machine vends.

	£	#
Sales	0.00	0
Discounts	0.00	0
Test Vend	0.00	0
Surcharge	0.00	0
Free Vend	4.00	4
Total	4.00	4

N.B. All sales data is presented in a format required by the latest European Vending Association Data Transfer Standard (EVA DTS).

1. The operator can also view and record audit data by individual product: Select **By Product** on the **Non Resettable Sales Data** menu screen. This menu contains all of the drink selections available from the machine.
2. Select the required product, e.g. **Chocolate**. The LCD will display the screen as shown below.

CRANE MERCHANDISING SYSTEMS <small>A Division of Cotyco</small>		Hot Chocolate	
← Previous page			
	£	#	
Price	1.00	1	
Sales	0.00	0	
Discounts	0.00	0	
Test Vend	0.00	0	
Surcharge	0.00	0	
Free Vend	0.00	0	

N.B. Individual **By Product** screens also display the price set for the selection as shown.

3. Press **Previous Page** to return to the By Product menu screen. The operator can then view data for more selections and also access further menus via the **Non Resettable Sales Data** menu relating to Cash, Cashless and Token audit data.

7.1.2 Resettable Sales Data

This menu contains similar data to that available from the Non Resettable Sales Data menu.

However, once viewed data from this menu can be cleared from the machine memory.

1. Select **Resettable Sales Data** (Overall Totals, By Product, Cash, Cashless or Token Vends).
2. Select **Overall Totals**. This menu displays both the total £ amount and total vend count (since the last time it was cleared) for the data fields shown.

N.B. See sub-section 7.1 Data Recall for detailed descriptions of these data fields.



	£	#
Sales	0.00	0
Discounts	0.00	0
Test Vend	0.00	0
Surcharge	0.00	0
Free Vend	0.00	0
Total	0.00	0

Once the operator has viewed required information from these submenus, the data can be deleted by pressing **Reset** then **Yes** to confirm. Press **Previous Page** to exit the menu without clearing the data.

3. The operator can also view resettable monetary and vend data for individual product by entering the By Product menu, and also view and record data relating to Cash, Cashless and Token Vends using their relevant sub-menus.

7.1.3 SureVend™

This menu allows the operator to view and reset data relating to the SureVend™ feature.

1. Select **SureVend™** (Cup Drop Failures, SV Assisted, Clear Data). The LCD will display the screen as shown. From this menu screen the operator can view the number of cup drop failures that SureVend™ has logged and also the number of SureVend™ assisted vends.
2. The data can be cleared by pressing **Clear Data** then **Yes** to confirm.



7.1.4 Mug Vends

This menu allows the operator to view the number of vends that the machine has made without dropping a cup.

1. Select **Mug Vends**.
2. The data can be cleared by pressing **Clear Data** then **Yes** to confirm.

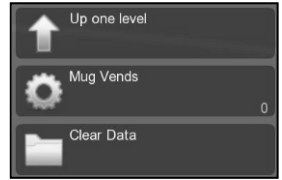

7.1.5 Cup Vends

This menu allows the operator to view the number of vends that the machine has made using a cup from within the machine.

1. Select **Data Recall / Cup Vends**.
2. The data can be cleared by pressing **Clear Data** then **Yes** to confirm.



7.2 Diagnostic

This menu allows the operator to view any current errors on the machine.

7.3 Price Menu

This menu allows the operator to view and change individual prices, one price for all drink selections, set a discount to be applied for customers who use their own cup/mug and view the currently set highest and lowest prices.

N.B. Values entered via this menu are only applicable to machines fitted with a monetary system.

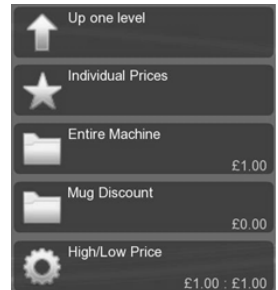

7.3.1 Individual Prices

This menu allows the operator to view and set an individual price for each drink selection available from the machine.

1. All drink selections available from the machine are listed along with the current drink price. The example shown illustrates an Instant Coffee selection with a price set currently at 35p.

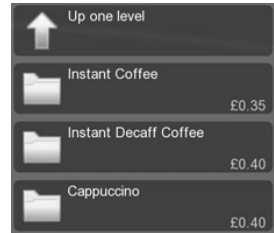

2. To change the price of the Instant Coffee, select **Instant Coffee**. The LCD will change and display the screen as shown below. To update the price, e.g. increase to 45p, press 4-5 using the appropriate touch-pads.

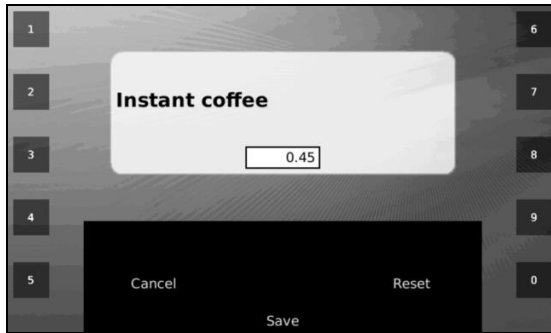

3. Press **Save**. The new price is now displayed. The operator can then update further selections.

7.3.2 Entire Machine

This menu allows the operator to view and set a single price for all selections available from the machine.



1. The LCD will display the screen, with the current value (e.g. 40p), as shown.
2. To update the value, e.g. set a price of 50p, press the sequence **5-0** using the appropriate touch-pads.
3. Press **Save** to keep the changes and return to the **Price** menu screen. The new price is now displayed.

Tip: If most selections are to be sold at the same price, use this menu to quickly set the entire machine to this price, then access the Individual Prices menu to adjust prices for individual selections. Entering a single price for the entire machine will over-ride any individual prices previously programmed.

7.3.3 Mug Discount

This menu allows the operator to view and set a discount value against all drink selections for customers who use their own cup/mug.

When a customer places their own cup into the dispense area and selects a drink, the SureVend™ sensors will detect the cup and disable the cup drop mechanism. The value set for Mug Discount is then subtracted from the price of the drink selected and the appropriate change/credit returned to the customer.

N.B. It is important to ensure that any value entered for a mug discount is supported by the coin mechanism fitted to the machine, e.g. if a mug discount is set at 2p but the lowest coin available from the coin mechanism is 5p, the machine will not return the discount to the customer.

1. The LCD will display the screen, with the current value (e.g. 5p), as shown.



2. To update the value, e.g. set a price of 10p, press the sequence **1-0** using the appropriate touch-pads.
3. Press **Save** to keep the changes and return to the **Price** menu screen. The new mug discount is now displayed.

7.3.4 View High/Low Price

This allows the operator to view the highest and lowest values in force, programmed via the Individual Prices sub menu.

N.B. If a single price is currently in force, this value will be displayed in both fields.

7.4 Product Configuration Menu

This menu allows the operator to view and change Heater Tank Setup, Selection Timers, Custom Selection Names, Jug Vend Configuration, Disable Selections, Token Enabled, SureVend™, Cup Mechanism, Brewer Waste Management and Water Filter Management.

7.4.1 Custom Selection Names

This menu allows the operator to change the type of soup or flavour of cold drink displayed to the customer on the main menu.

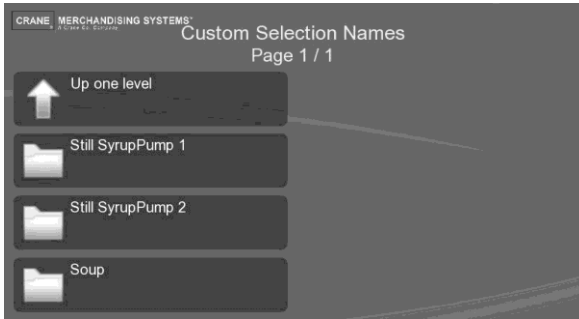

The following example describes how to update the machine to display Tomato Soup instead of Soup.

1. Select **Soup**

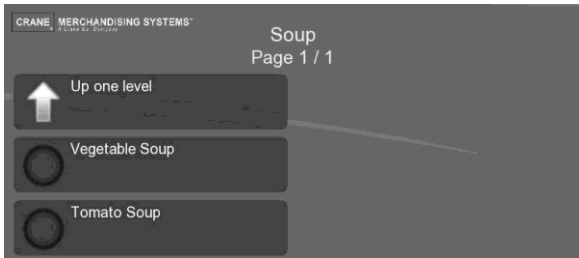

2. Select **Tomato Soup**

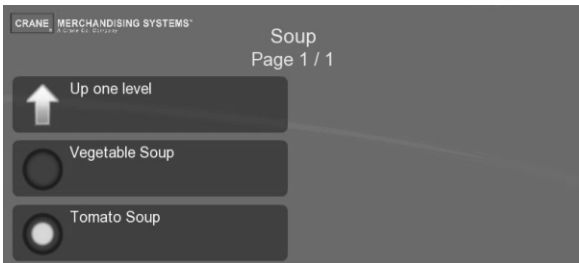

3. Press **Up one level**

Note: the cold drink flavour is adjusted in the same way.

7.4.2 Disable Selections

This menu allows the operator to disable individual drink selections.

The following example describes how to disable drink selections Instant Coffee, Espresso and Cappuccino

1. Select **Disable Selections**.
2. Press the touch key adjacent to the drinks selections to be disabled, a **TICK** appears in its adjacent box indicating that it is now disabled.
3. Press **Up One Level**.

Note: On the standby screen any drink selections that have been disabled appear greyed out with the word “Unavailable” underneath and the touch-pad not illuminated.

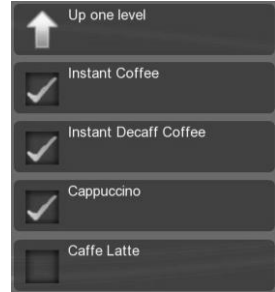

7.4.3 SureVend™

This menu allows the operator to turn the SureVend™ product delivery feature on or off.

SureVend™ Overview

SureVend™ ensures that a cup is always available in the cup station before any money is collected or product delivered. The sensing system is a beam of infra-red light across the cup station that is broken by a cup as it falls into position from the cup drop unit, or by a customer placing his own mug in the dispense area.

The SureVend™ software monitors the cup station sensor during the time that the cup ring is operated. If a cup is not detected the software will then attempt to drop a cup a second and if necessary, a third time if a cup has still not been dispensed the main screen will display “Product Not Dispensed”

Customers can now get their money back by pressing the coin return button or removing their card.

If this happens on three consecutive occasions the main screen will display the message “**Please Insert Mug**”. The machine remains in service but will not vend a cup from the cup drop unit.

To clear the message and return to standby mode open the door, if necessary, remove the damaged cup from the cup drop unit.

Ensure correct operation before leaving the machine.

To configure SureVend™ proceed as follows:

1. Select **SureVend™**
2. Press the touch-pad adjacent to the required option

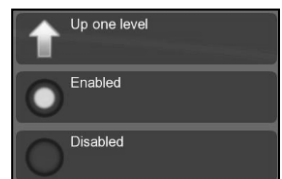

3. Press **Up one level**

N.B. By default SureVend™ is factory set to Enabled as indicated by the status line at the bottom of the screen.

7.4.4 - Free Vend

This menu allows the operator to enable/disable Free Vend when the machine is fitted with a coin/card system. When Free Vend is enabled, all available drinks selections will be dispensed at no cost. To enable Free Vend, proceed as follows:

1. Select **Free Vend**.
2. Select **Enabled** or **Disabled** as required
3. Press **Up One Level**.

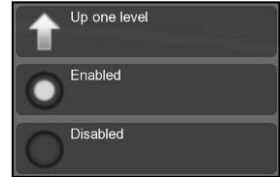

7.4.5 - Leave Service Application

Allows operator to return machine to Standby Mode

1. Select **Leave Service Application**
2. Press **Yes**

Section 8 - Dispense Pipe Lengths

There are three sizes of pipe used on a Coti machine which can be replaced by the Operator:

CoEx Espresso Brewer = 4mm white silicone

CoEx Brewer - non espresso and Oltre Fresh Brew Brewer = 8mm grey silicone

All others = 6mm grey silicone

To replace pipes:

1. Open cabinet door and extend the delivery head by pressing **8** on the service keypad.
2. Using the above information about pipe size connect the pipes to the dispense head; the numbers on the diagram below indicate which mixing bowl/brewer should be connected to which nozzle.
3. The pipes should be cut to such lengths that when the head is in this extended position they are not too taut and neither does the pipe sag below the delivery head.

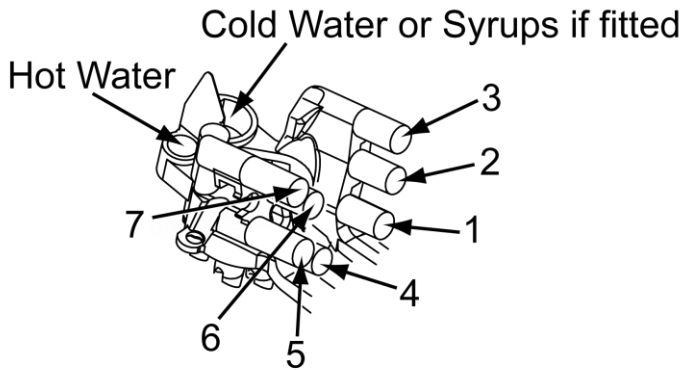

N.B. Soups must be connected to 1 or 4

Section 9 – Recommended Spare Parts

The spares items listed on the following pages are available from your machine supplier and will ensure long and trouble free service from your machine.

9.1 Hygiene Kits

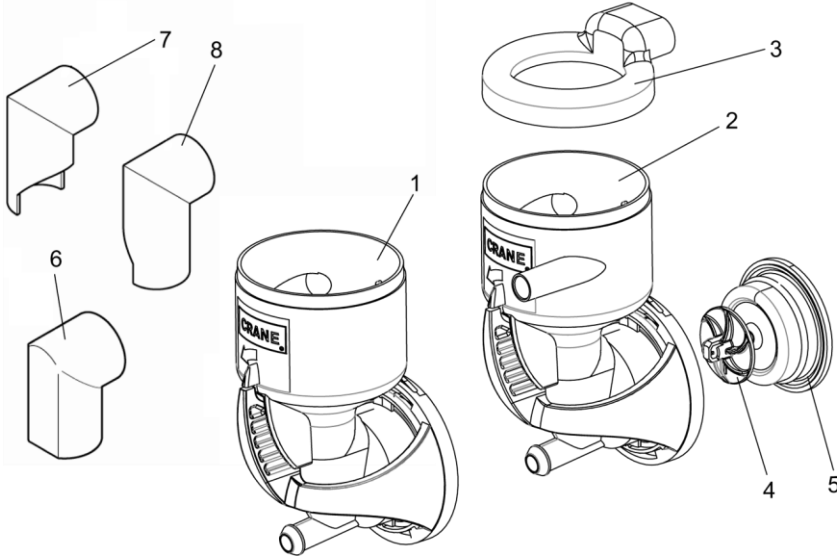

Hygiene Kit - Part No. (& item quantity per kit)

Ref No.	Item	ABH HYG INSTANT (Instant)	ABH HYG SFBT (Fresh brew Tea)	ABH HYG DFB EU (Double Fresh brew Coffee & Tea)	ABH HYG B2C FBT (B2C Fresh brew Tea)
1	Whipper bowl, single inlet	7	4	3	3
2	Whipper bowl, dual inlet	-	-	1	-
3	Stream trap	7	4	4	3
4	Impeller	7	4	4	3
5	Seal	7	4	4	3
6	Chute, canister central	6	-	-	-
7	Chute, LH, long	1	4	4	4
8	Chute, RH, long	1	5	4	4
Not shown	Silicone, pipe 8mm x 12.5mm	0.65 M	0.65 M	0.65 M	0.65 M
	Silicone, pipe 6mm x 9.5mm	3.00 M	3.00 M	3.00 M	3.00 M

9.2 Dispense Area Components

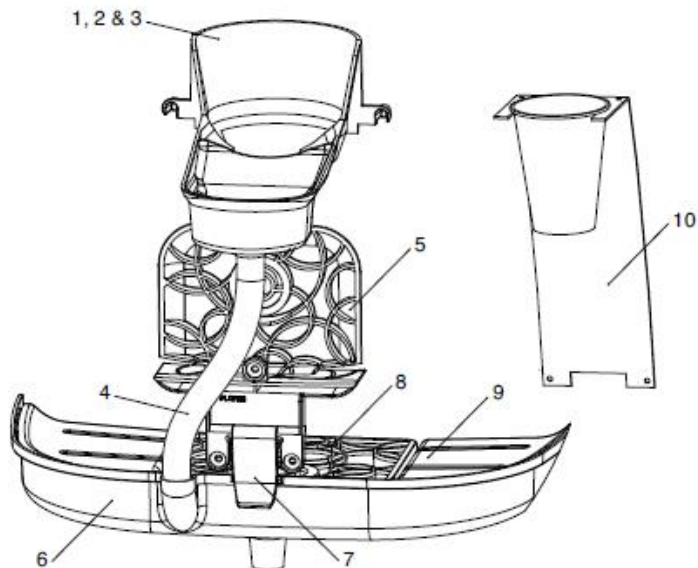

Ref No.	Part No.	Item Description
1	PL13126000	Cup Catcher Moulding - Squat Cup
2	PL13125000	Cup Catcher Moulding - Tall Cup
3	PL13128000	Cup Catcher Moulding - 12oz Cup
4	SIO1142960	Silicon pipe - 16mm OD
5	PL13123000	Cup Stand
6	PL13131000	Drip Tray
7	PL13122000	Mounting Bracket, Cup Stand
8	PL13133000	Grille
9	PL13132000	Surround, Grille
10	MT11611000	Mounting Bracket, Drip Catcher

Section 10 - Error Messages and Simple Problem Solving

10.1 Error Messages

The table below lists the error messages that may be encountered and, where applicable, offers the operator solutions for curing them.



Safety First! Should the solution given not cure the problem, or the fault requires the assistance of a trained service engineer, **DO NOT ATTEMPT TO CURE THE FAULT YOURSELF.** Contact your machine supplier for assistance.

Error message	Cause	Solution
Co-Ex® Clean Recommended	Co-Ex® brewer has not been routinely cleaned	Perform a tablet clean (button 10) using the service keypad at earliest opportunity
Co-Ex® Clean Required	The cleaning routine has not been followed & the Co-Ex® brewer disabled	Perform a tablet clean (button 10) using the service keypad immediately
Co-Ex® Setup Required	Co-Ex® brewer has not been setup	Call an engineer, Freshbrew and B2C drinks cannot be dispensed
Out Of Cups Please Insert Mug	Cup stacks empty SureVend™ has detected an error with the cup drop unit	Refill cup stacks with correct size and type of cup Check the CDU, if error remains call engineer
Please Remove Cup	A cup or mug has been left in the vend area	Remove the cup or mug to cancel the error
Sorry Out of Service	Mug Sensor Error	Fault with mug sensor
	No IO Comm	Communications fault
	Brewer Not Homed	Brewer has not returned to its home position
	Brewer Jam	Brewer mechanism faulty
	Head Not Homed	Dispense head has not returned to its home position
	Head Not Extended	Dispense head has not moved to its extended position
	No Monetary Device	The monetary device is not connected or has been configured incorrectly
	Invalid Temperature	The temperature device is disconnected or faulty
	Water Tank Leak	The dispense valve is leaking

Error message	Cause	Solution	
Low Water	The machine is filling	Wait for the machine to fill with water	
Fill Timeout	The machine has failed to fill with water	Check that the water supply to the machine is connected and turned on	
Sorry out of service	Water Tank Heating	The water is heating to the correct operating temperature	Wait for the machine to heat up and enter standby mode
	Waste Bucket Full	The waste bucket is full	Empty, clean and refit the waste bucket
	Rinsing	Operator/engineer running the rinse program	Wait until machine completes rinse cycle and returns
	Out of Coffee	Fresh beans canister and/or fresh brew canister empty (B2C machines) Bean canister shut-off closed	Refill bean canister with fresh beans and/or coffee canister with fresh brew coffee Fully open bean canister shutoff

10.2 Simple Problem Solving

In the unlikely event of the machine developing a problem, details are given in the table below on how to deal with common faults that can be easily remedied by the operator.



Safety First! Should the remedy given below not cure the problem, or the fault is not listed, DO NOT ATTEMPT TO CURE THE FAULT YOURSELF. Contact your machine supplier for assistance.

Fault	Possible Cause	Remedy
Waste bucket overflowing	Level sensor incorrectly located in the bucket	Ensure sensor is positioned correctly in the bucket
Incorrect drinks dispensed	Ingredient canisters located incorrectly	Refit canisters into their correct positions
Leaking from dispense area	Mixing system/'O' ring fitted incorrectly	Refit correctly and ensure that all mixing stations are water tight
Blank LCD display	Electricity supply turned off	Ensure electricity supply is turned on at the mains
Cups jamming	Incorrect cup size	Remove cups from cup stack and replace with correct size cups
No change given from change giver (where fitted)	Coin tubes jamming Coin tubes empty or below pre-set level	Clear coin tubes and check for blockage Check and refill coin tubes where necessary
Low water indicated on LCD display	Water supply turned off	Ensure water supply is turned on at stop tap

Fault	Possible Cause	Remedy
Carbonated drinks not "fizzy"	CO2 gas bottle empty	Check and if necessary replace
Paper fed brewer unit jamming	Incorrect paper fitted	Remove and fit correct 90mm filter paper
	Filter paper loaded incorrectly	Reload paper and ensure that it feeds correctly
	Paper fouling on brewer guard	Adjust brewer guard DO NOT REMOVE
Brewer wiper arms not removing coffee/tea waste. (Paperless fresh brew only)	Brewer chambers refitted incorrectly after cleaning	Refit brewer chambers ensuring that wiper lugs are located correctly
'Selection Not Available' on LCD and machine will not vend coffee based drinks (B2C machines)	Waste counter has reached maximum number of vends dispensed through CoEx® brewer	Empty coffee waste bin and reset waste counter (see subsection 5.12 for details)

10.3 Machine Leaking

Should the machine develop a leak, switch off the mains water supply at the stop-tap and if safe to do so, switch off the mains electricity supply.



Safety First! Do not attempt to repair the machine yourself.

Section 11 - Decommissioning Your Machine

1. Should the machine need to be shut down for short periods, for example over a long weekend, no special treatment is required. The machine should be thoroughly cleaned before the site is closed down and on return it is advisable to vend each drink type to ensure correct operation of the machine.
2. If the machine is to be moved or transported, remove all ingredients and thoroughly clean the machine. Contact the supplier of the machine as only fully trained service engineers are authorised to carry out the decommissioning of a machine.

Visit the **Tech Zone** on our website to find this
and other manuals and technical information for
the complete Crane machine range

www.cranems.co.uk/technical/

CRANE[®] MERCHANDISING SYSTEMS

Pipsmore Park, Bumpers Farm Industrial Estate,
Chippenham, Wiltshire, SN14 6NQ
Tel: +44 (0)1249 444807 Fax +44 (0)1249 444819
Email: sales@cranems.co.uk
Website: www.cranems.co.uk